

Technical Sheet

Cookers 600 EV Series Electric Ovens

Jemi Simply built to last

Professional Dishwashing
and Cooking Equipment

Selva de Mar, 122-128
08020 Barcelona, España
Tel. 0034 93 308 31 54
Fax. 0034 93 303 38 73
jemi@jemi.es
www.jemi.es

Mod. H6E EV

Characteristics

External dimensions 800 x 600 x 700 mm.

Weight 53 Kg.

Oven dimensions 530 x 410 x 320 mm.

Electric inlet 400V. III + T.

Power 6 Kw.

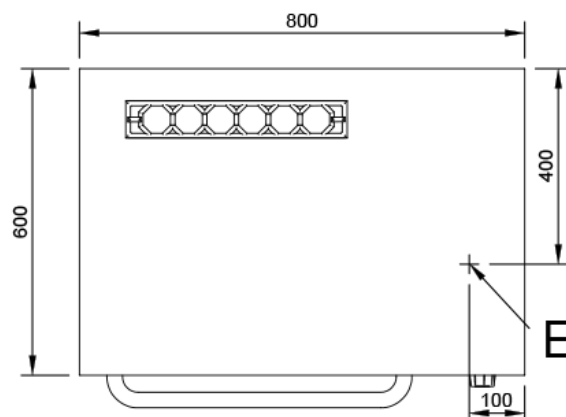
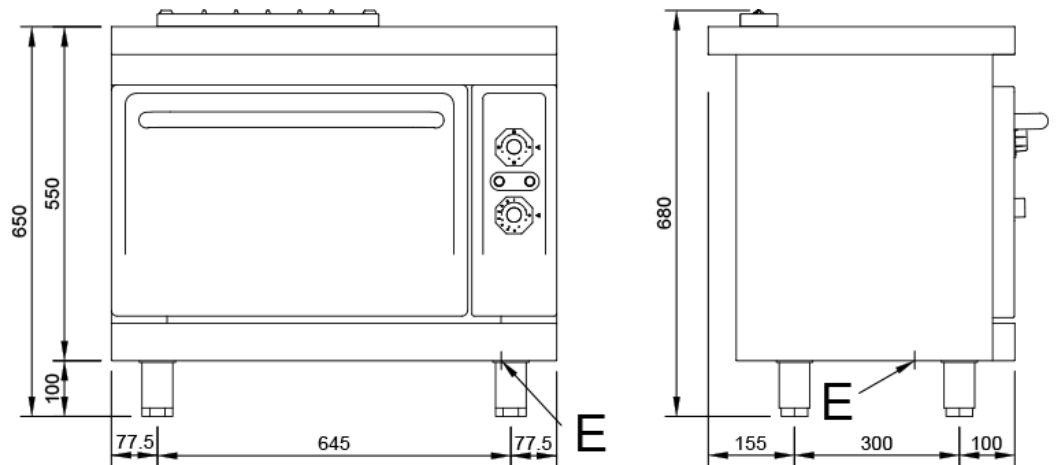

Index

E. Electric inlet 400V. III + T.
Power: 6 Kw.

