

Ficha Técnica

Cocina Serie 900 EV Freidoras Eléctricas

Jemi Simply built to last

Professional Dishwashing
and Cooking Equipment

Selva de Mar, 122-128
08020 Barcelona, España
Tel. 0034 93 308 31 54
Fax. 0034 93 303 38 73
jemi@jemi.es
www.jemi.es

Mod. FRE90/2 EV

Características

Dimensiones exteriores	800 x 900 x 850 mm.
Peso	115 Kg.
Voltaje	400V. III + N + T.
Dimensiones cuba	305 x 510 x 388 mm.
Capacidad cuba	23 + 23 litros.
Numero de cestas	4 sencillas o 2 dobles
Dimensiones cesta sencilla	130 x 445 x 105 mm.
Dimensiones cesta doble	285 x 445 x 105 mm.
Potencia eléctrica	36 Kw.

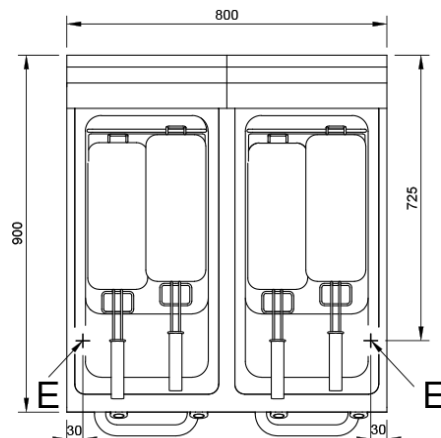
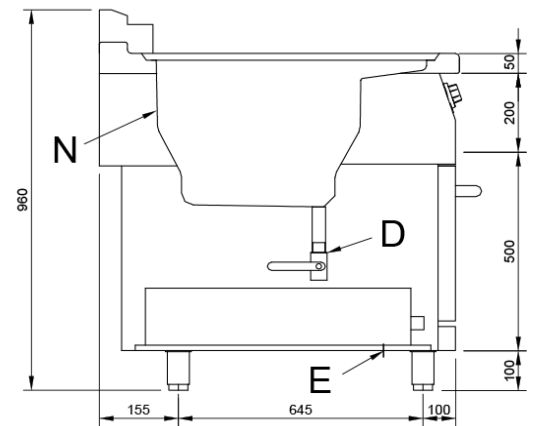
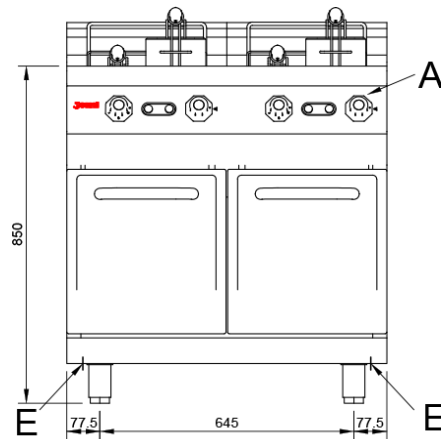

Leyenda

- A. Placa de características (frontal interior)
 - D. Desagüe.
 - E. Entrada eléctrica 400V. III + N + T.
 - N. Nivel.
- Potencia: 36 Kw.

