

Technical Sheet

Cookers 900 EV Series Electric Fryers

Jemi Simply built to last

Professional Dishwashing
and Cooking Equipment

Selva de Mar, 122-128
08020 Barcelona, España
Tel. 0034 93 308 31 54
Fax. 0034 93 303 38 73
jemi@jemi.es
www.jemi.es

Mod. FRE90/2 EV

Characteristics

Externals dimensions	800 x 900 x 850 mm.
Weight	115 Kg.
Voltage	400V. III + N + T.
Tank dimensions	305 x 510 x 388 mm.
Tank capacity	23 + 23 litres.
Number of baskets	4 singles or 2 doubles
Dimensions basket single	130 x 445 x 105 mm.
Dimensions basket double	285 x 445 x 105 mm.
Electric power	36 Kw.

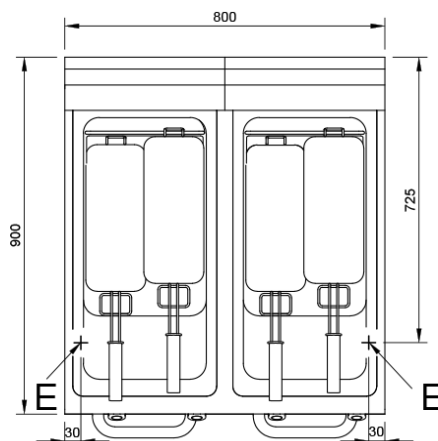
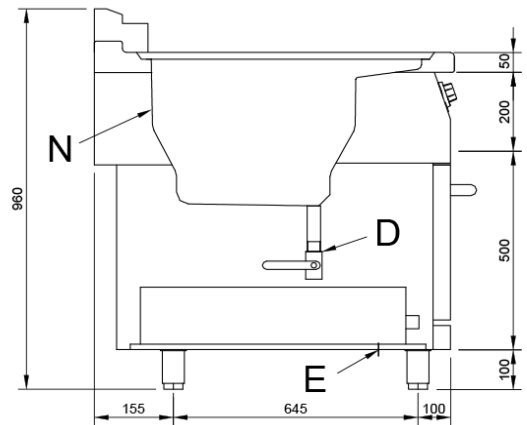
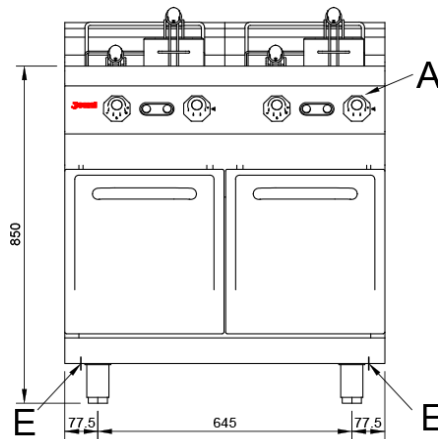

Index

- A. Characteristics plate (inside panel)
 - D. Drain.
 - E Electric inlet 400V. III + N + T.
 - N. Level
- Power: 36 Kw.

